

EXTREME PRESENTATION[™] *WORKSHOP*

36 Page Layout Ideas

(Please insert into Extreme Presentation Binder Appendix)

August, 2006

Andrew V. Abela, Ph.D.

Layout Options 1

Decisions & Alternatives

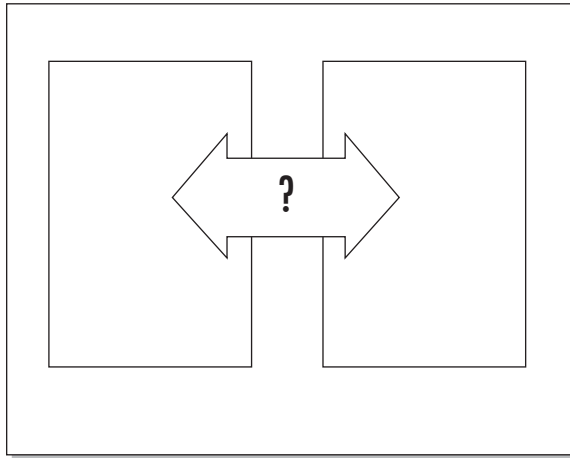

Two Alternatives

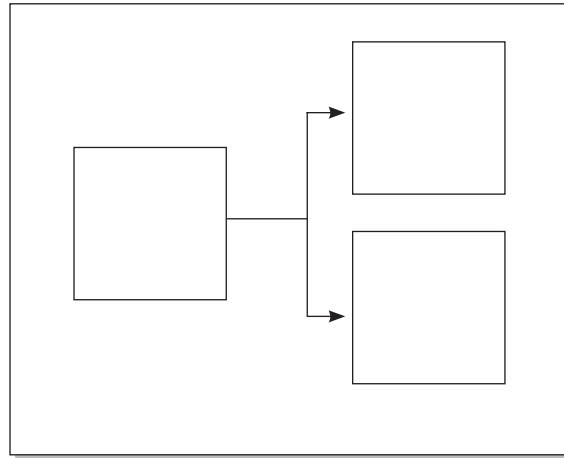

Decision

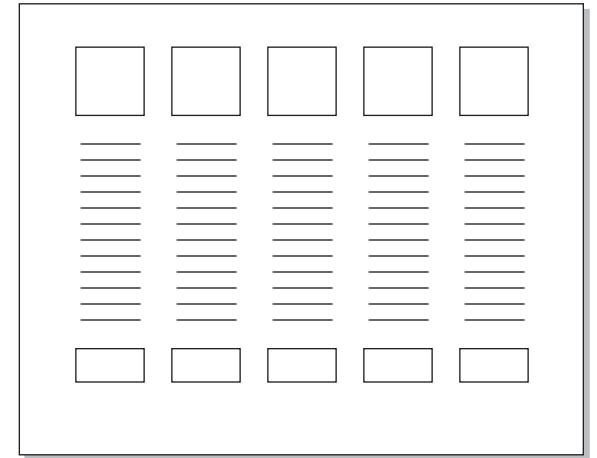

Multiple Alternatives

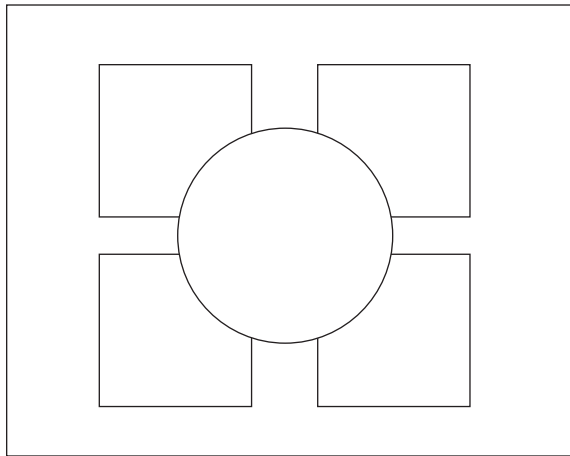

Converging Issues

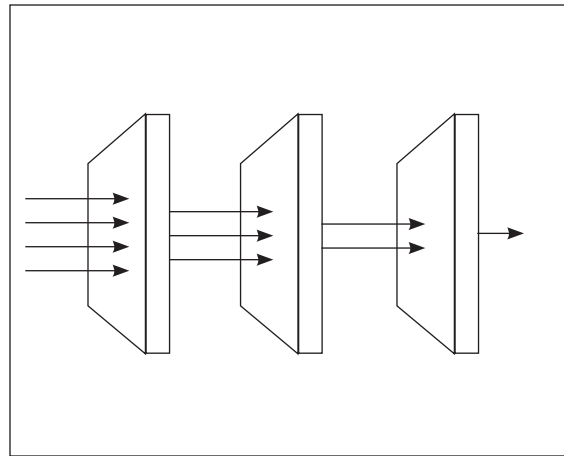

Screening Alternatives

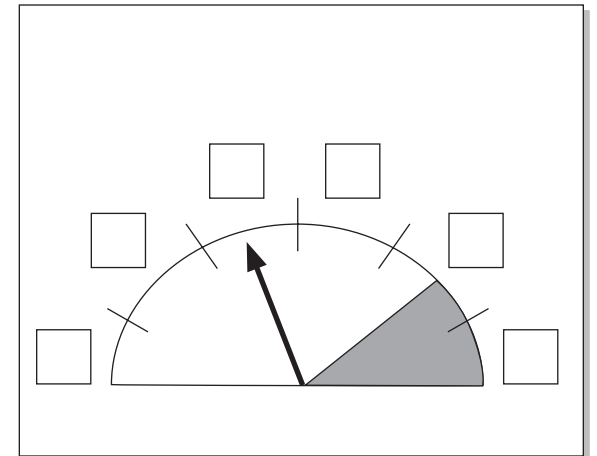

Avoiding Extreme Alternatives

Source: Several of these layouts are adapted from G. Zelazny, *Saying It with Charts* and M. Craig, *Thinking Visually*.

Layout Options 2

Processes and Progress

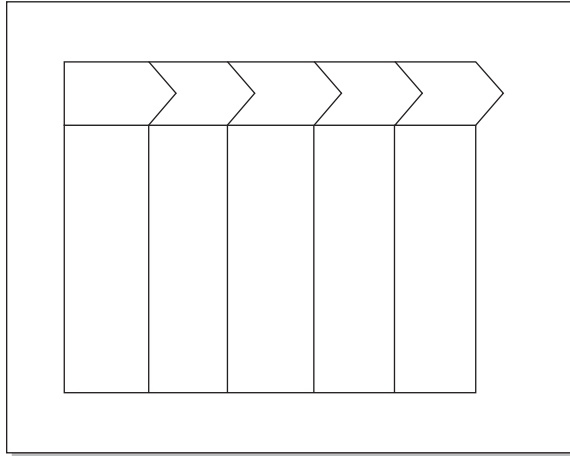

Detailed Process

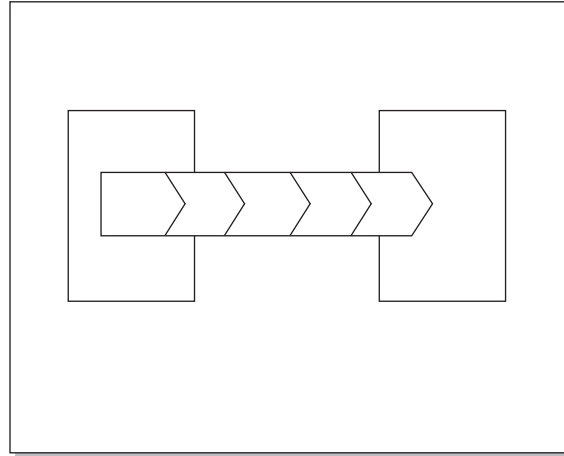

From-To Process

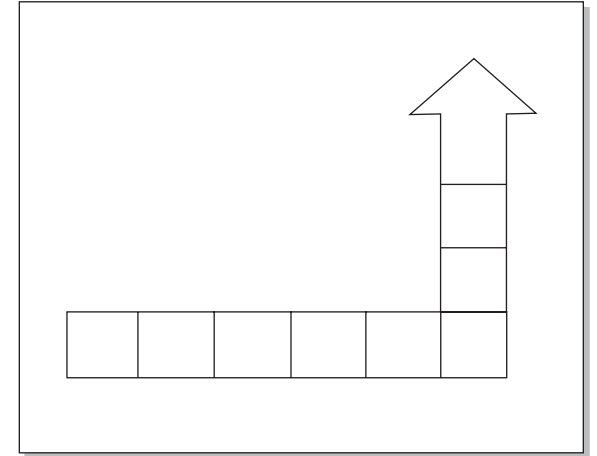

Course Change

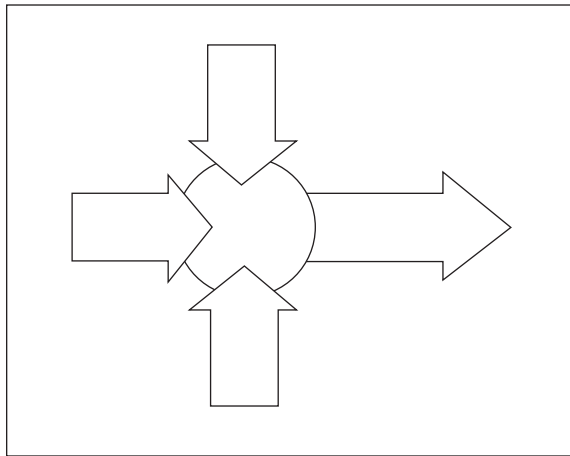

Alignment

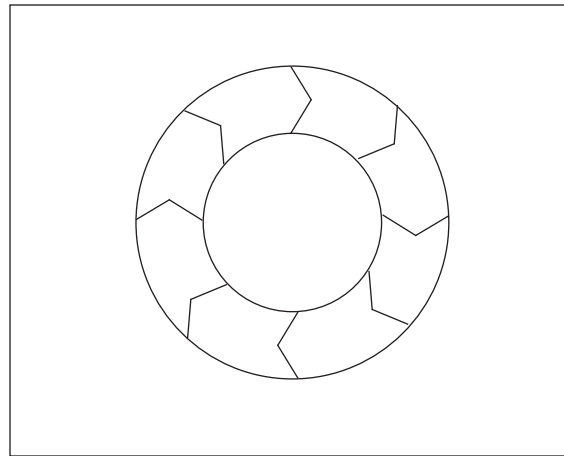

Cyclical Process

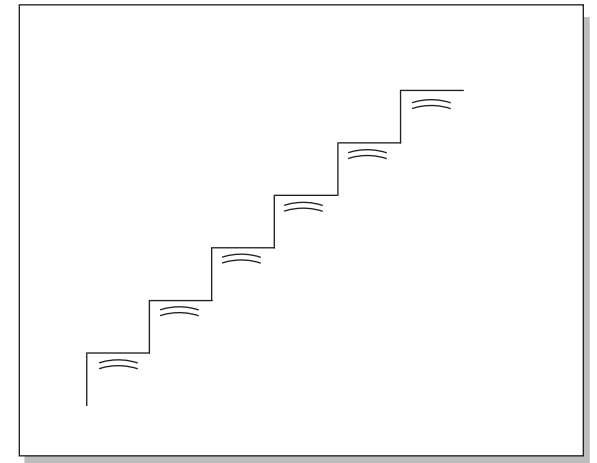

Improvement Steps

Layout Options 3

More Processes and Progress

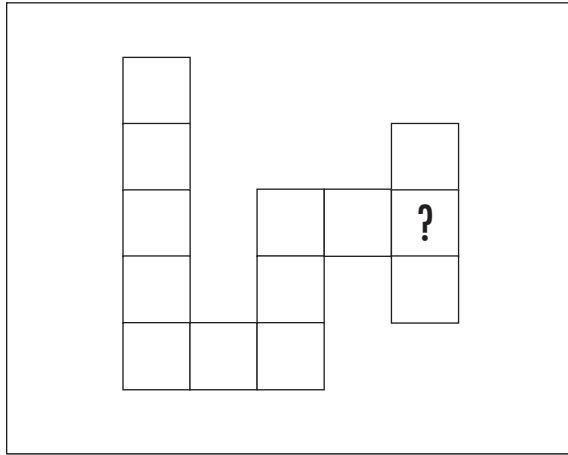

Gameboard—Complex Process

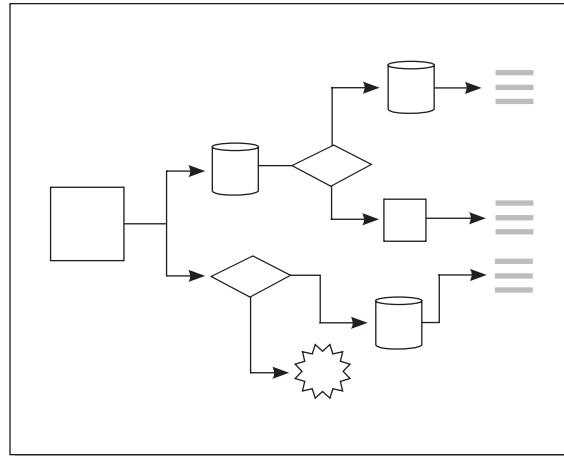

Flowchart/Process Diagram

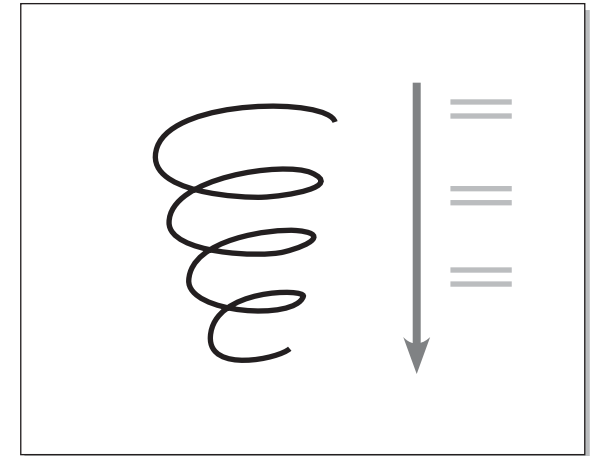

Downward Spiral (Reverse for Upward)

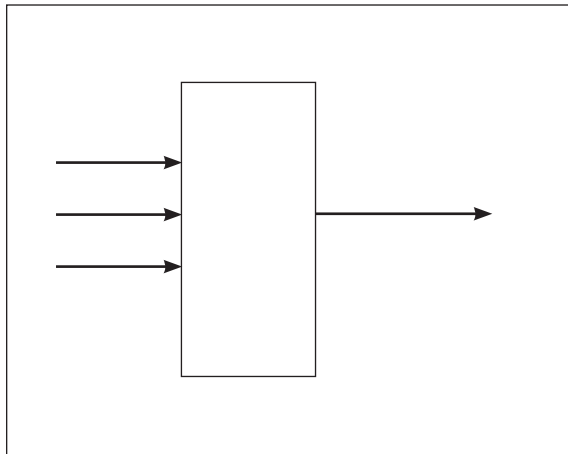

Inputs and Outputs

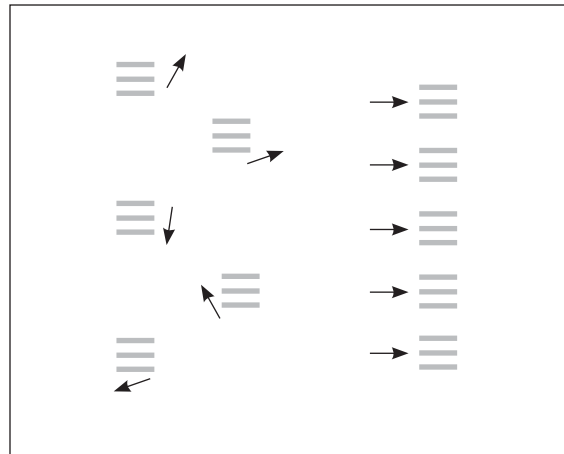

From Chaos to Alignment

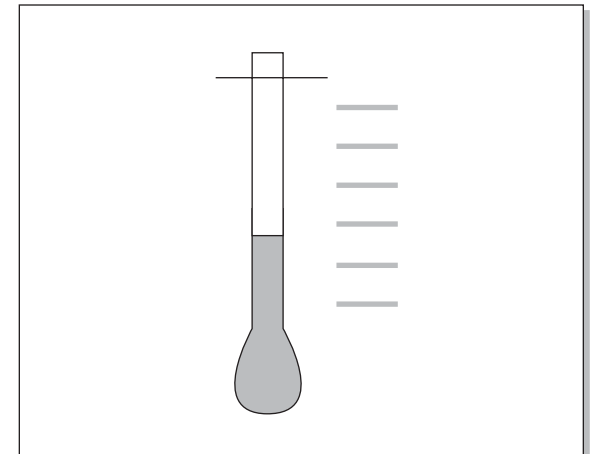

Progress Towards Goal

Layout Options 4

Problems (“Opportunities”)

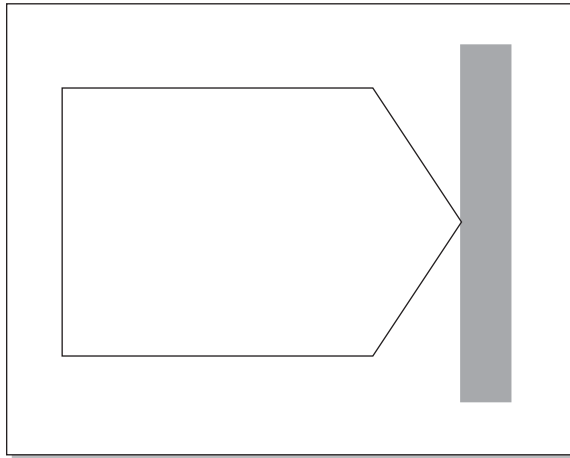

Barrier

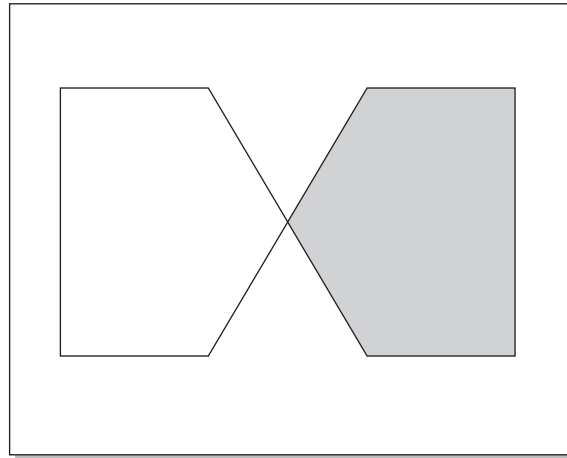

Tension

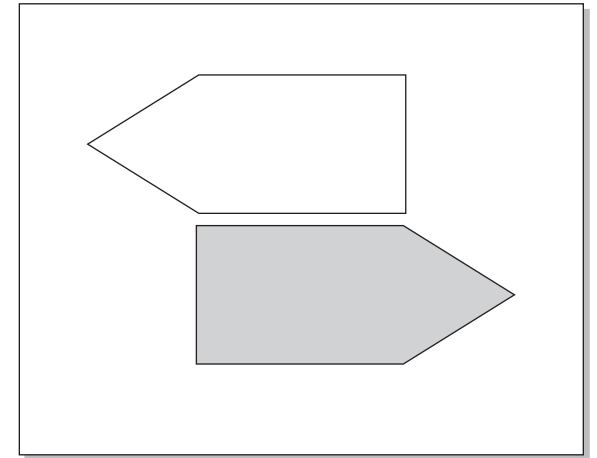

Diverging Approaches or Ideas



Tip of the Iceberg

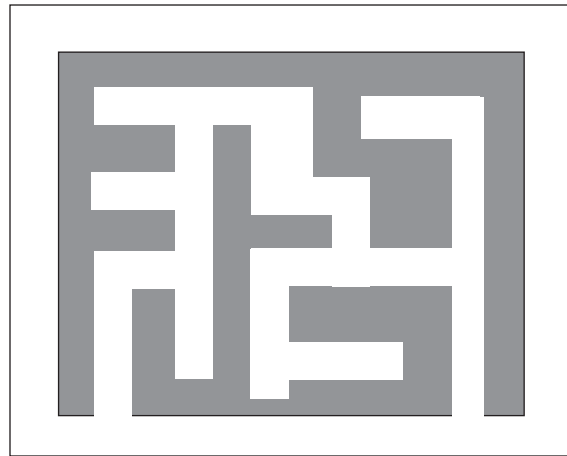

Maze—Confusion

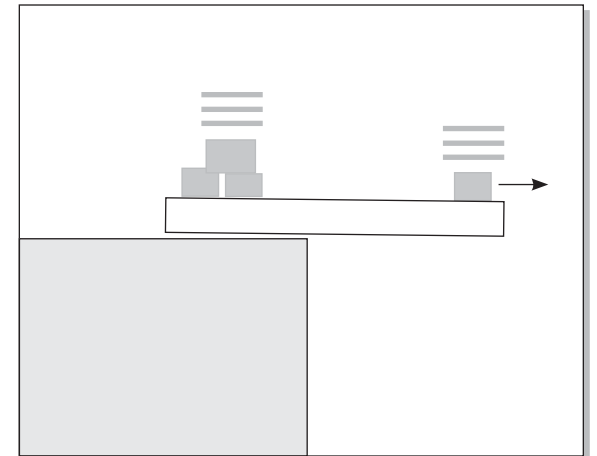

On the Edge

Layout Options 5

Balance and Miscellaneous

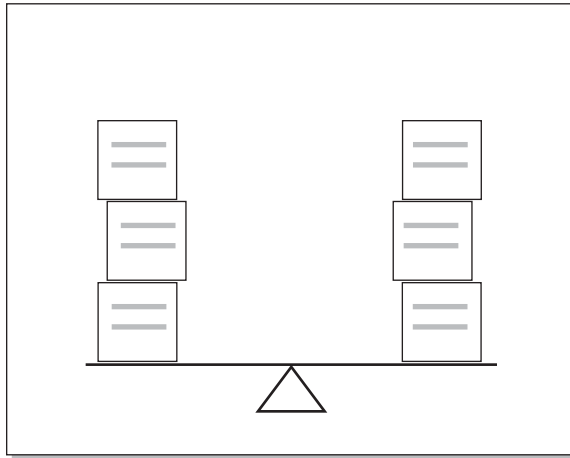

Balance

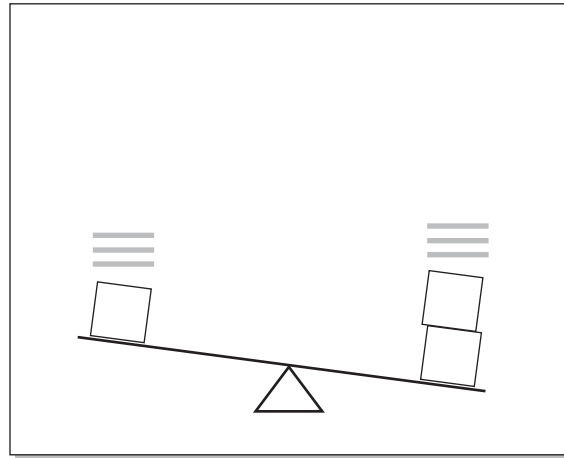

Out of Balance

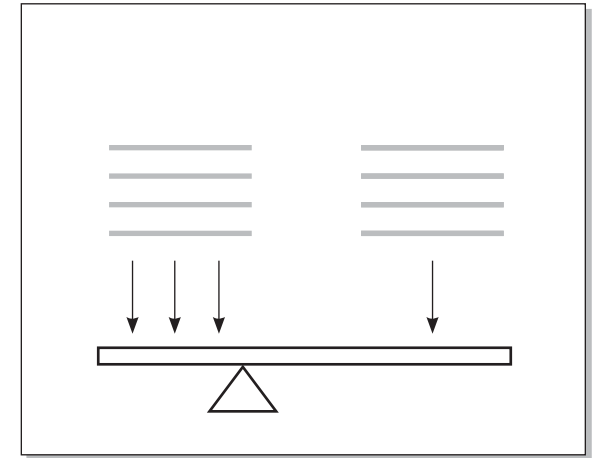

Leverage

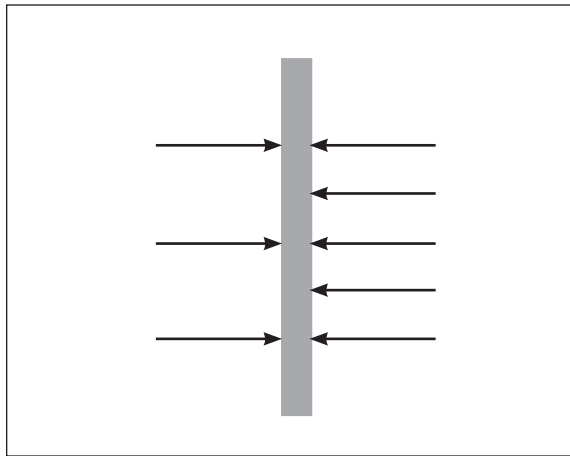

Forcefield—Pros and Cons

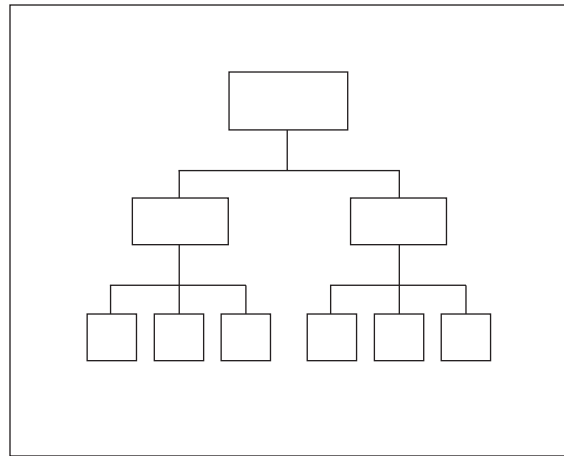

Organization Chart

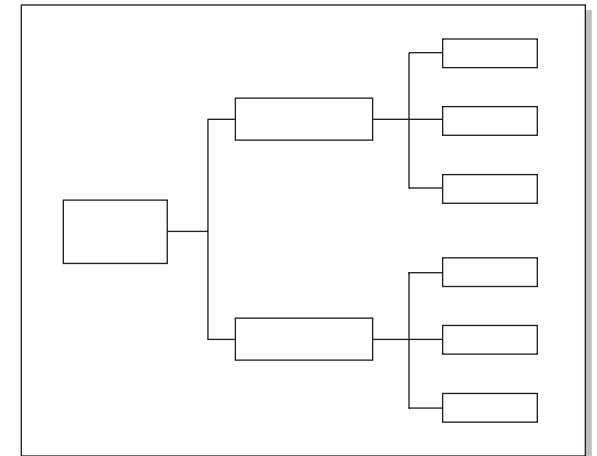

Problem Disaggregation or Decision Tree

Layout Options 6

More Miscellaneous

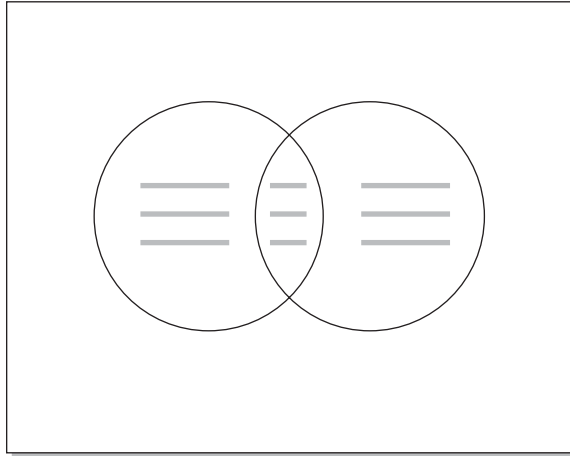

Relationship

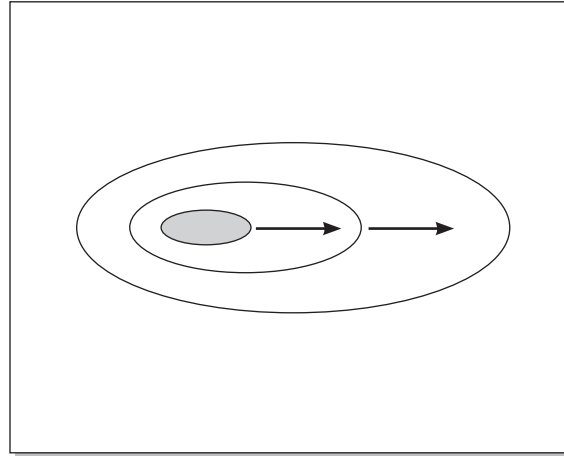

Growth Opportunity

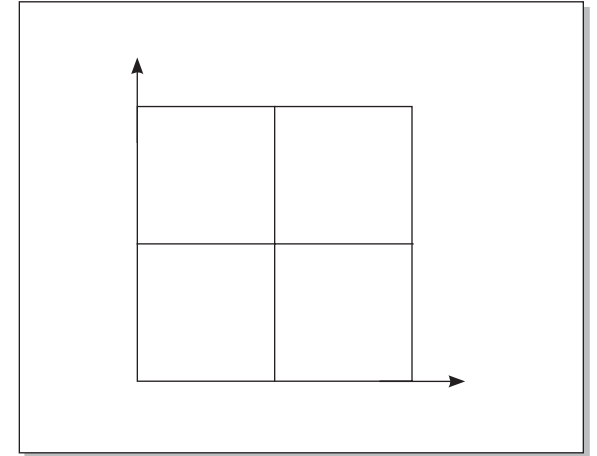

Segmentation (Two Dimensions)

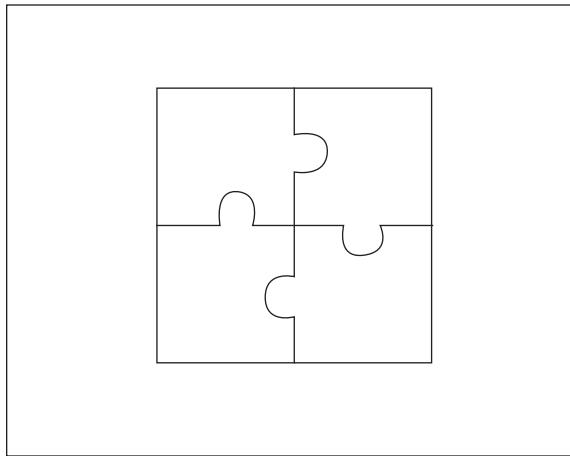

Component–Puzzle

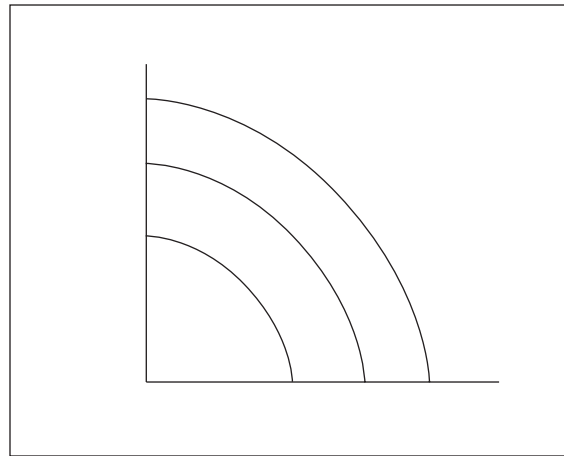

Growth Opportunity (Two Dimensions)

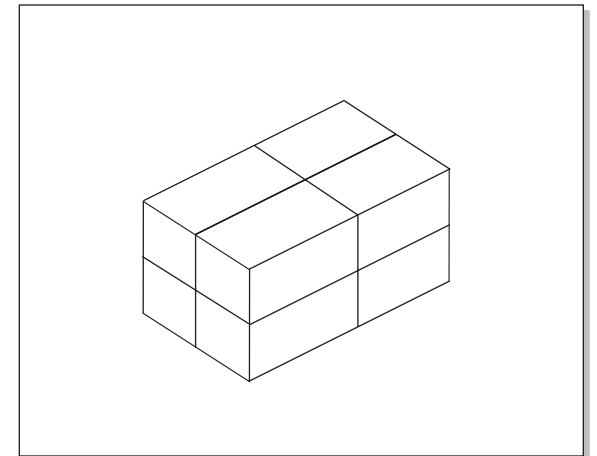

Segmentation (Three Dimensions)